

QUIET POWER RELAY

1 POLE—20 A

(FOR AUTOMOTIVE APPLICATIONS)

FTR-P1 SERIES

■ FEATURES

- Original construction, where reduction of operational noise is considered when mounted on PCB, made it possible to design this quiet relay.
(Average acoustic noise level: 53 dB, distance 10 cm)
- New types of materials are used for the conductive parts, allowing this compact relay to carry 20 AMP.
- Two types of contact material are available for various contact loads.
- Wider contact gap (0.6 mm) version is also available for enhanced cut-off ability to overload condition.



■ ORDERING INFORMATION

[Example] $\frac{\text{FTR-P1}}{\text{(a)}} \frac{\text{C}}{\text{(b)}} \frac{\text{N}}{\text{(c)}} \frac{\text{012}}{\text{(d)}} \frac{\text{W1}}{\text{(e)}} \frac{\text{---}}{\text{(f)}}$

(a)	Series Name	FTR-P1: FTR-P1 Relay
(b)	Contact Arrangement	C : 1 form C (SPDT)
(c)	Contact Gap	N : 0.3 mm gap P : 0.6 mm gap
(d)	Nominal Voltage	009 : 9 VDC 010 : 10 VDC 012 : 12 VDC
(e)	Contact Material	W1 : Silver-tin oxide-indium
(f)	Custom Designation	To be assigned for custom specification

Note: Part No. is printed on the top of relay as follows.
(Example) Designation ordered: FTR-P1CN012W1
Stamp: P1CN012W1

FTR-P1 SERIES (QUIET TYPE)

■ SPECIFICATIONS

Item		Specifications	
Contact	Arrangement	1 form C (SPDT)	
	Material	Silver-tin oxide-indium (W1 type)	
	Voltage Drop (resistance)	Maximum 100 mV (at 2 A 12 VDC)	
	Ratings	14 VDC/20 A (locked motor load) 14 VDC/inrush 20 A, break 4 A (motor free load)	
	Maximum Carrying Current	20 A/ 1 hour (25°C, 100% rated coil voltage)	
	Maximum Inrush Current (reference)	W1 Type: 60 A	
	Max. Switching Current (reference)	30 A at 16 VDC	
	Min. Switching Load*1 (reference)	6 VDC 1 A	
Coil	Operating Temperature Range	-40°C to +85°C (no frost) (refer to the CHARACTERISTIC DATA)	
	Storage Temperature Range	-40°C to +100°C (no frost)	
Time Value	Operate (at nominal voltage)	Maximum 10 ms	
	Release (at nominal voltage)	Maximum 5 ms	
Life	Mechanical	1 × 10 ⁷ operations minimum	
	Electrical	2 × 10 ⁵ operations minimum (locked motor load) 4 × 10 ⁵ operations minimum (motor free load)	
Other	Vibration Resistance	10 to 55 Hz (double amplitude of 1.5 mm)	
	Shock Resistance	Misoperation	100 m/s ²
		Endurance	1,000 m/s ²
	Weight	Approximately 10.0 g	

*1 Values when switching a resistive load at normal room temperature and humidity, and in a clean environment. The minimum applicable load varies with the switching frequency and operating environment.

■ COIL DATA CHART

● 0.3 mm contact gap type

MODEL	Nominal voltage	Coil resistance (±10%)	Must operate voltage	Must release voltage	Thermal resistance
W1 TYPE					
FTR-P1CN009W1	9 VDC	135 Ω	5.4 V (at 20°C) 6.8 V (at 85°C)	0.7 V	73°C/W
FTR-P1CN010W1	10 VDC	180 Ω	6.3 V (at 20°C) 7.9 V (at 85°C)	0.8 V	
FTR-P1CN012W1	12 VDC	240 Ω	7.3 V (at 20°C) 9.2 V (at 85°C)	0.9 V	

FTR-P1 SERIES (QUIET TYPE)

● 0.6 mm Contact Gap Type

MODEL	Nominal voltage	Coil resistance ($\pm 10\%$)	Must operate voltage	Must release voltage	Thermal resistance
W1 TYPE					
FTR-P1CP009W1	9 VDC	100 Ω	5.4 V (at 20°C) 6.8 V (at 85°C)	0.7 V	65°C/W
FTR-P1CP010W1	10 VDC	135 Ω	6.3 V (at 20°C) 7.9 V (at 85°C)	0.8 V	
FTR-P1CP012W1	12 VDC	180 Ω	7.3 V (at 20°C) 9.2 V (at 85°C)	0.9 V	

Note: Values in the table of coil resistance and must release voltage are measured at 20°C.

■ SUITABLE APPLICATION

CONTACT MATERIAL	SUITABLE LOAD
W1: Silver-tin oxide-indium	Door lock Power window Solenoids, etc. (locked rotor)

■ CHARACTERISTIC DATA

1. MAXIMUM BREAK CAPACITY

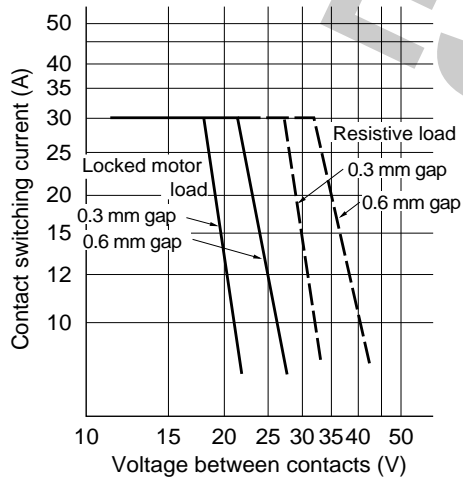

2. LIFE

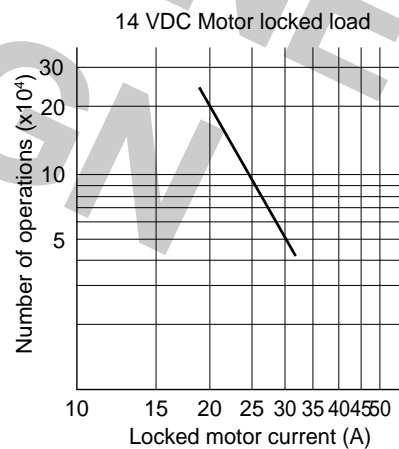

FTR-P1 SERIES (QUIET TYPE)

3. LIFE TEST (EXAMPLE)

- Test item
14 V DC-20 A
Motor Lock
200,000 operations
minimum

- Test circuit

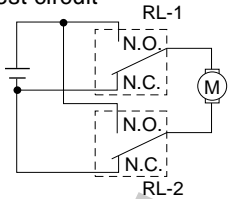

- Shift of pick-up drop-out voltage

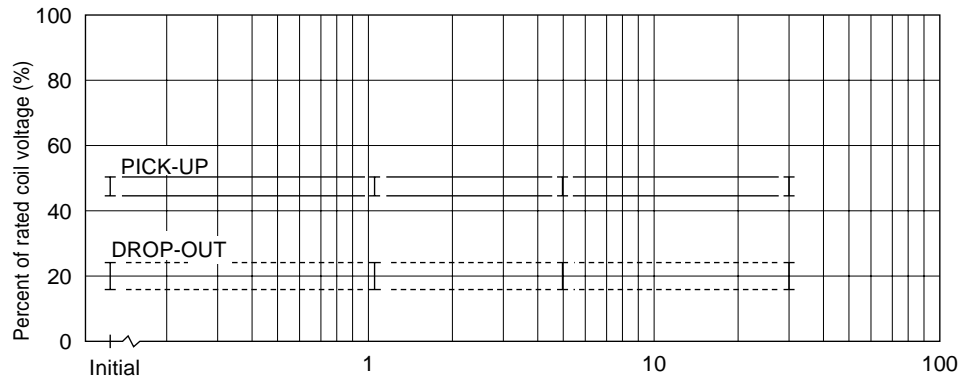

- Current wave form

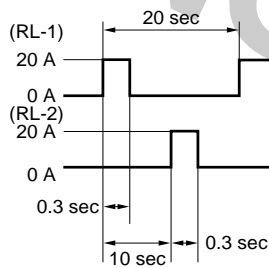

- Shift of contact resistance

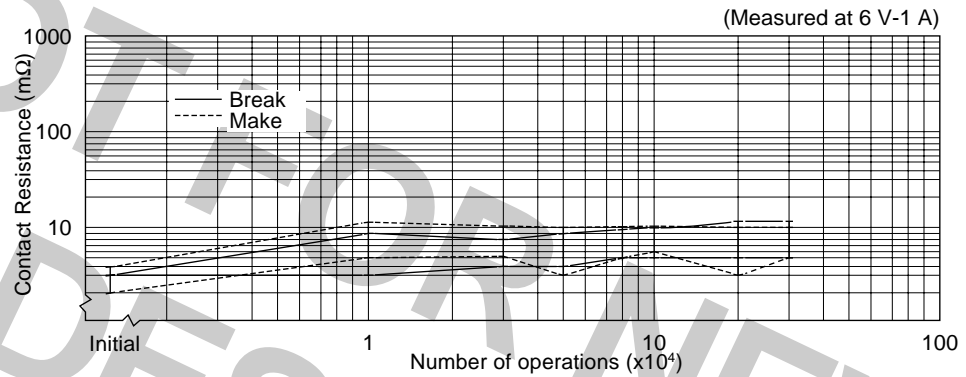

- Test item
14 V DC-20 A
motor free
400,000 operations
minimum

- Test circuit

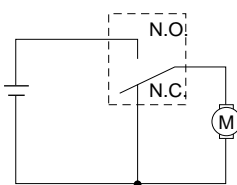

- Shift of pick-up drop-out voltage

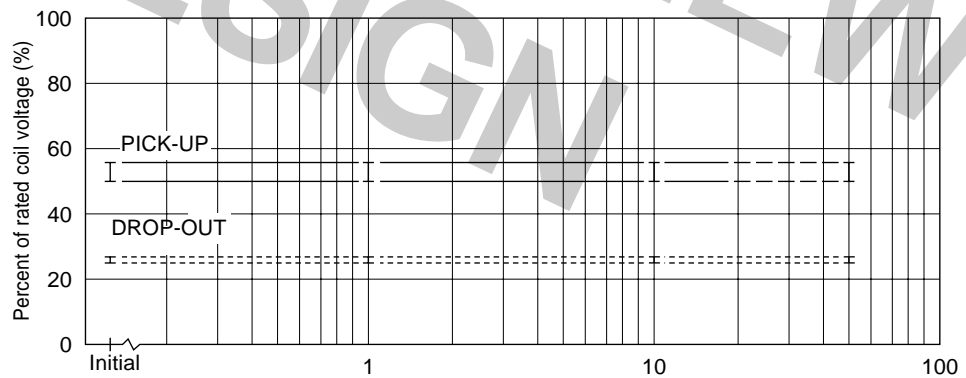

- Shift of contact resistance

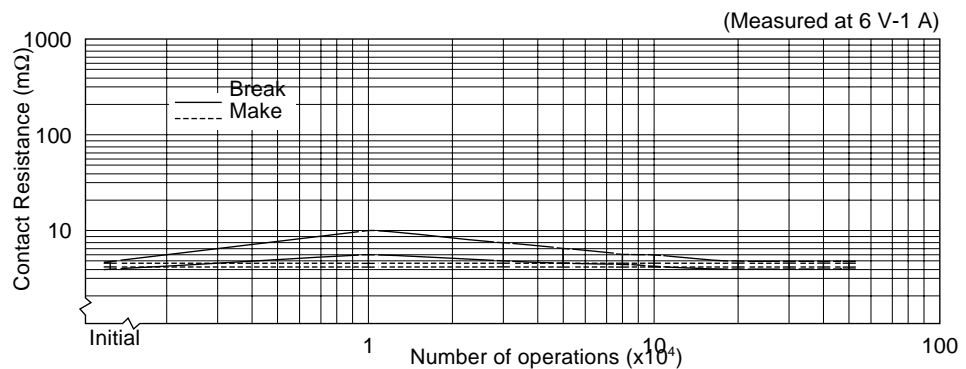

- Current wave form

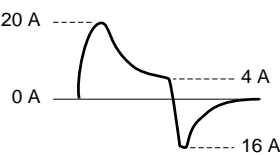

FTR-P1 SERIES (QUIET TYPE)

4. COIL TEMPERATURE RISE

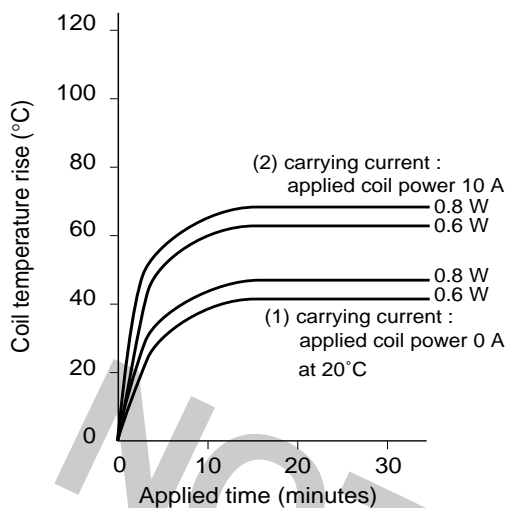

5. OPERATING COIL VOLTAGE RANGE (EXAMPLE)

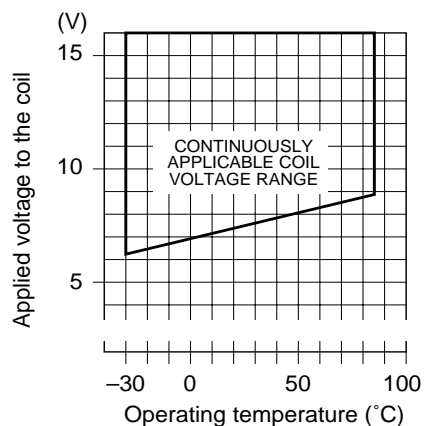

6. VIBRATION RESISTANCE CHARACTERISTICS

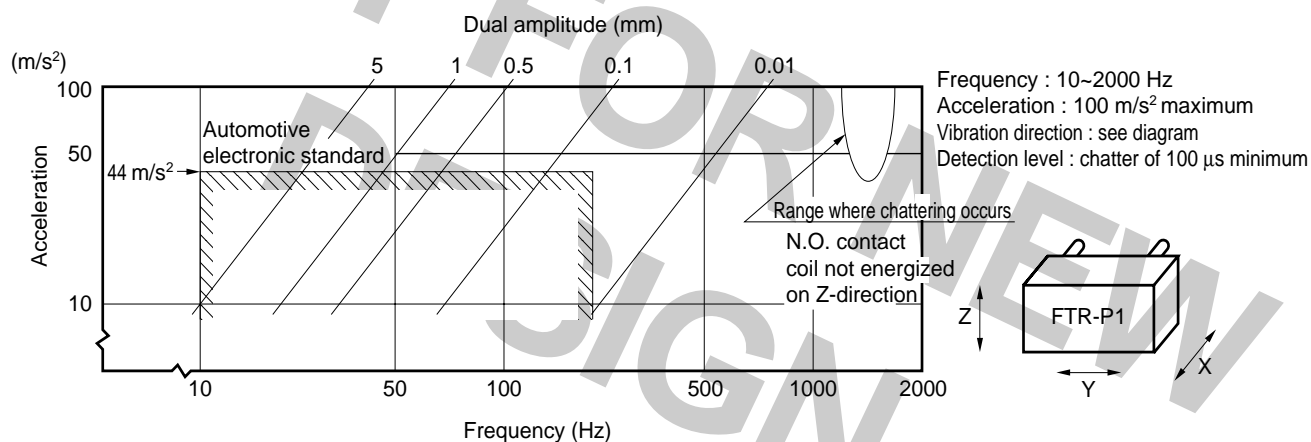

7. SHOCK RESISTANCE CHARACTERISTICS

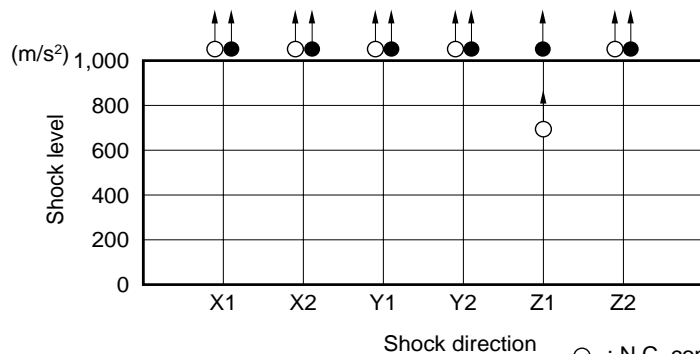

Shock application time : 11 ms, half-sine wave
 Test material : coil, energized and de-energized
 Shock direction : see diagram
 Detection level : chatter of 100 μs minimum

○ : N.C. contact (coil de-energized)
 ● : N.C. contact (coil energized)

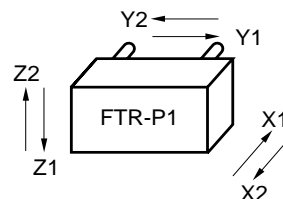

FTR-P1 SERIES (QUIET TYPE)

REFERENCE DATA

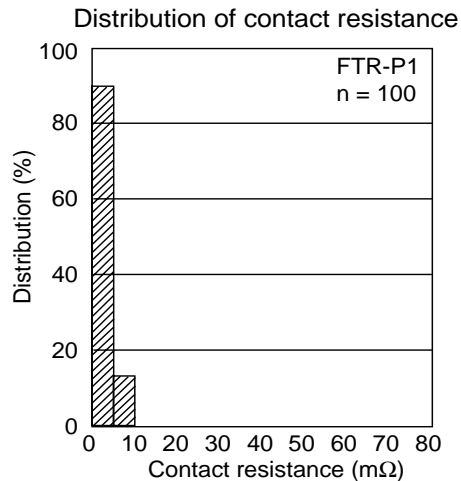
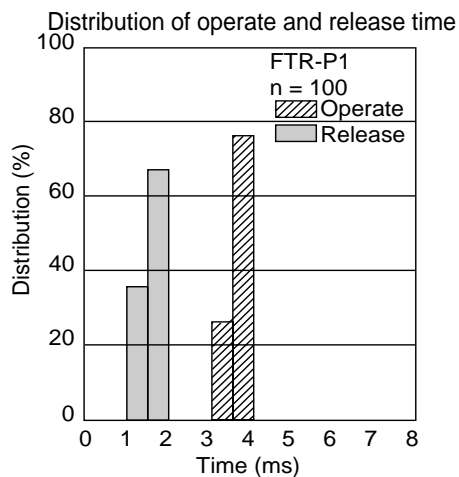
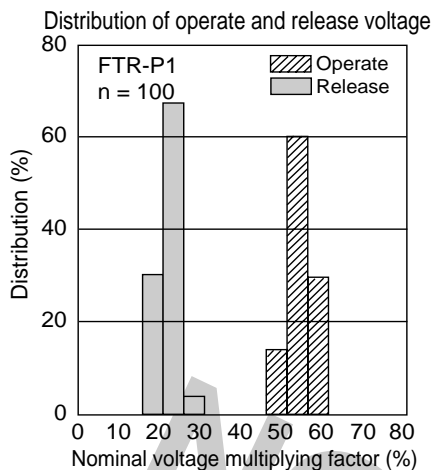

DIMENSIONS

Dimensions

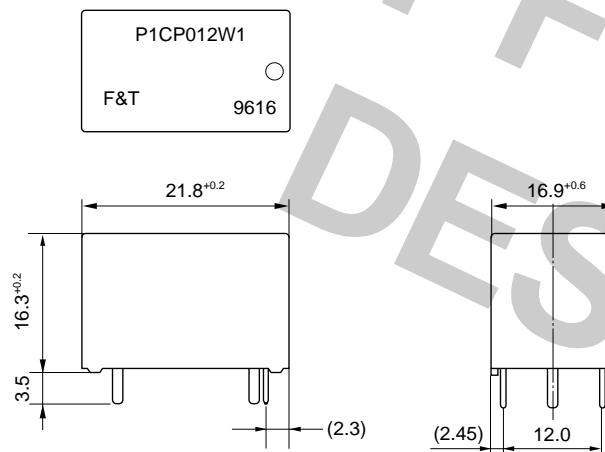

Mounting hole layout (BOTTOM VIEW)

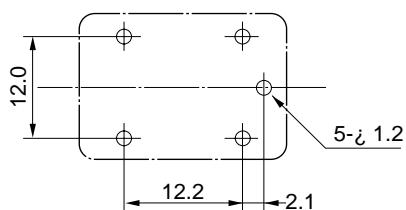

Tolerance -0.1

Schematic (BOTTOM VIEW)

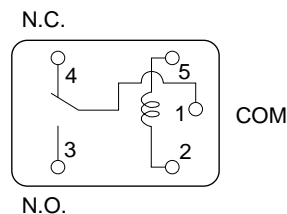

Unit : mm

FTR-P1 SERIES (QUIET TYPE)

Fujitsu Components International Headquarter Offices

Japan

Fujitsu Component Limited
Gotanda-Chuo Building
3-5, Higashigotanda 2-chome, Shinagawa-ku
Tokyo 141, Japan
Tel: (81-3) 5449-7010
Fax: (81-3) 5449-2626
Email: promothq@ft.ed.fujitsu.com
Web: www.fcl.fujitsu.com

North and South America

Fujitsu Components America, Inc.
250 E. Caribbean Drive
Sunnyvale, CA 94089 U.S.A.
Tel: (1-408) 745-4900
Fax: (1-408) 745-4970
Email: marcom@fcai.fujitsu.com
Web: www.fcai.fujitsu.com

Europe

Fujitsu Components Europe B.V.
Diamantlaan 25
2132 WV Hoofddorp
Netherlands
Tel: (31-23) 5560910
Fax: (31-23) 5560950
Email: info@fceu.fujitsu.com
Web: www.fceu.fujitsu.com

Asia Pacific

Fujitsu Components Asia Ltd.
102E Pasir Panjang Road
#04-01 Citilink Warehouse Complex
Singapore 118529
Tel: (65) 6375-8560
Fax: (65) 6273-3021
Email: fcal@fcal.fujitsu.com
www.fcal.fujitsu.com

© 2005 Fujitsu Components America, Inc. All company and product names are trademarks or registered trademarks of their respective owners. Rev.06/07/2005

NOT FOR NEW DESIGN