

## **200KHz, 1.5A PWM Buck DC/DC Converter**

### ❖ GENERAL DESCRIPTION

The AX3022 series are monolithic IC designed for a step-down DC/DC converter, and own the ability of driving a 1.5A load without additional transistor. It saves board space. The external shutdown function can be controlled by logic level and then come into standby mode. The internal compensation makes feedback control having good line and load regulation without external design. Regarding protected function, thermal shutdown is to prevent over temperature operating from damage, and current limit is against over current operating of the output switch. If current limit function occurs and  $V_{FB}$  is down below 0.5V, the switching frequency will be reduced. The AX3022 series operates at a switching frequency of 200KHz thus allow smaller sized filter components than what would be needed with lower frequency switching regulators. Other features include a guaranteed +3% tolerance on output voltage under specified input voltage and output load conditions, The chips are available in a standard SOT89-5L package.

### ❖ FEATURES

- Output voltage: adjustable output version.
- Adjustable version output voltage range: 0.75V to 22V+3%.
- 200KHz fixed switching frequency.
- Voltage mode non-synchronous PWM control.
- Thermal-shutdown and current-limit protection.
- ON/OFF shutdown control input.
- Short Circuit Protect (SCP).
- Operating voltage can be up to 24V.
- Output load current: 1.5A.
- SOT89-5L Pb-Free packages.
- Low power standby mode.
- Built-in switching transistor on chip.

❖ **BLOCK DIAGRAM**

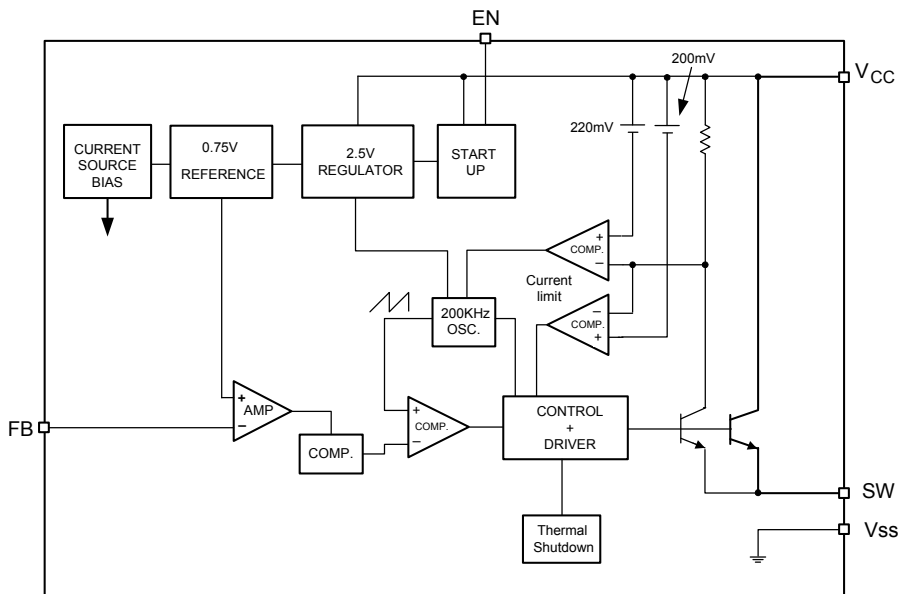

❖ **PIN ASSIGNMENT**

The package of AX3022 is SOT89-5L; the pin assignment is given by:

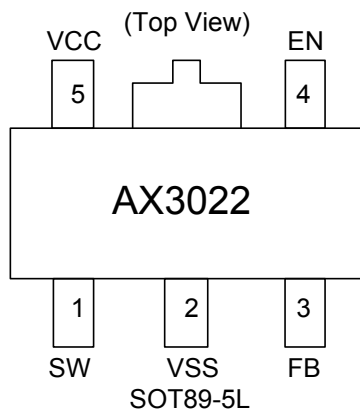

Name	Description
VCC	Operating voltage input
SW	Switching output
FB	Output voltage feedback control
EN	ON/OFF Shutdown
VSS	GND pin

❖ **ORDER/MARKING INFORMATION**

Order Information	Top Marking
<p><b>AX3022 XX X</b></p> <p>Package Type: F5: SOT89-5L</p> <p>Packing: Blank : Tube, A : Taping</p>	<p>3 0 2 2 → Part number</p> <p>Y W X → ID code: internal</p> <p>WW: 01~26 (A~Z), 27~52 (a~z)</p> <p>Year: A=2010, 1=2011</p>

### ❖ ABSOLUTE MAXIMUM RATINGS

Characteristics	Symbol	Rating	Unit
Maximum Supply Voltage	V <sub>CC</sub>	+26	V
ON/OFF Pin Input Voltage	V <sub>EN</sub>	-0.3 to V <sub>CC</sub>	V
Feedback Pin Voltage	V <sub>FB</sub>	-0.3 to 12	V
Output Voltage to Ground	V <sub>OUT</sub>	-0.8	V
Power Dissipation Internally limited	PD	(T <sub>J</sub> -T <sub>A</sub> ) / θ <sub>JA</sub>	W
Storage Temperature Range	T <sub>ST</sub>	-65 to +150	°C
Operating Junction Temperature Range	T <sub>J</sub>	-20 to +125	°C
Operating Supply Voltage	V <sub>OP</sub>	+4.5 to +24	V
Thermal Resistance from Junction to case	θ <sub>JC</sub>	15	°C/W
Thermal Resistance from Junction to ambient	θ <sub>JA</sub>	50	°C/W

Note: θ<sub>JA</sub> is measured with the PCB copper area(need connect to V<sub>SS</sub> pins) of approximately 1.5 in<sup>2</sup> (Multi-layer).

### ❖ ELECTRICAL CHARACTERISTICS

(Unless otherwise specified, T<sub>A</sub>=25°C, V<sub>CC</sub>=12V, V<sub>OUT</sub>=3.3V, I<sub>OUT</sub> = 0.2A)

Characteristics	Symbol	Conditions	Min	Typ	Max	Units
Feedback Voltage	V <sub>FB</sub>	I <sub>OUT</sub> =0.2A	0.728	0.750	0.773	V
Quiescent Current	I <sub>Q</sub>	V <sub>FB</sub> =1.2V force driver off		4	8	mA
Feedback bias current	I <sub>FB</sub>	I <sub>OUT</sub> =0.1A		-10	-50	nA
Shutdown supply Current	I <sub>SD</sub>	V <sub>EN</sub> =0V	-	2	10	uA
Oscillator frequency	F <sub>OSC</sub>		140	200	260	KHz
Oscillator frequency of short circuit protect	F <sub>SCP</sub>	(Adjustable) When V <sub>FB</sub> <0.5V		80		KHz
Max. Duty Cycle (ON)	DC	V <sub>FB</sub> =1.2V force driver off		0		%
Min. Duty Cycle (OFF)		V <sub>FB</sub> =0V force driver on		100		
Current limit	I <sub>CL</sub>	Peak current, No outside circuit V <sub>FB</sub> =0V force driver on	1.8			A
Saturation voltage	V <sub>SAT</sub>	I <sub>OUT</sub> =1.5A, No outside circuit V <sub>FB</sub> =0V force driver on		1.2	1.5	V
SW pin leakage current SW pin=0V	I <sub>SWL</sub>	No outside circuit V <sub>FB</sub> =1.0V force driver off			-200	uA
SW pin leakage current SW pin=-0.8V		V <sub>CC</sub> =24V force driver off		-5		mA
EN pin logic input threshold voltage	V <sub>IH</sub>	High (regulator ON)	-	1.2	2.0	V
	V <sub>IL</sub>	Low (regulator OFF)	0.5		-	
EN pin logic input current	I <sub>H</sub>	V <sub>EN</sub> =2.5V (ON)	-	20	-	uA
EN pin input current	I <sub>L</sub>	V <sub>EN</sub> =0.3V (OFF)	-	-5	-	
Thermal shutdown Temp	T <sub>SD</sub>			135		°C

❖ **APPLICATION CIRCUIT**  
Adjustable Output Voltage Version

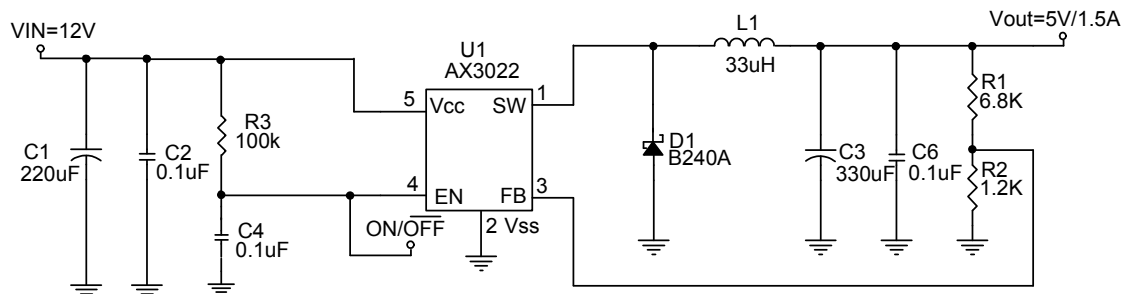

$$V_{OUT} = V_{FB} \times \left(1 + \frac{R1}{R2}\right), V_{FB} = 0.75V, R2 = 0.75K \sim 4K$$

Table 1 Resistor select for output voltage setting

V <sub>OUT</sub>	R2	R1
5V	1.2K	6.8K
3.3V	2K	6.8K
2.5V	2K	4.7K
1.8V	2K	3K
1.5V	2K	2K
1.3V	2K	1.5K
1.2V	2K	1.2K

L1 recommend value (V <sub>IN</sub> =12V ,I <sub>OUT</sub> =1.5A,)				
V <sub>OUT</sub>	1.8 V	2.5V	3.3V	5V
L1 Value	22uH	22uH	33uH	33uH

❖ **FUNCTION DESCRIPTIONS**

**Pin Functions**

**V<sub>CC</sub>**

This is the positive input supply for the IC switching regulator. A suitable input bypass capacitor must be presented at this pin to minimize voltage transients and to supply the switching currents needed by the regulator.

## **V<sub>SS</sub>**

Circuit ground.

## **SW**

Internal switch. The voltage at this pin switches between  $(+V_{CC} - V_{SAT})$  and approximately  $-0.5V$ , with a duty cycle of approximately  $V_{OUT} / V_{CC}$ . To minimize coupling to sensitive circuitry, the PC board copper area connected to this pin should be minimized.

## **Feedback**

Senses the regulated output voltage to complete the feedback loop.

## **EN**

Allows the switching regulator circuit to be shutdown using logic level signals thus dropping the total input supply current to approximately 10uA. Pulling this pin below a threshold voltage of approximately 0.5V shuts the regulator down, and pulling this pin above 2.0V (up to a maximum of  $V_{CC}$ ) turns the regulator on.

## **Thermal Considerations**

The SOT89-5L package needs a heat sink under most conditions. The size of the heat sink depends on the input voltage, the output voltage, the load current and the ambient temperature. The AX3022 junction temperature rises above ambient temperature for a 1.5A load and different input and output voltages.

For the best thermal performance, wide copper traces and generous amounts of PCB copper (need connect to the  $V_{SS}$  pins) should be used in the board layout, (One exception is the SW pin, which should not have large areas of copper.) Large areas of copper provide the best transfer of heat (lower thermal resistance) to the surrounding air, and moving air lowers the thermal resistance even further.

**Lead Pattern Recommendation (Unit: mm)**

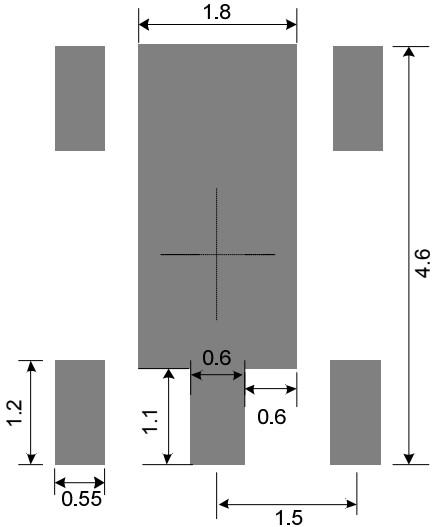

❖ TYPICAL CHARACTERISTICS

VFB VS VIN

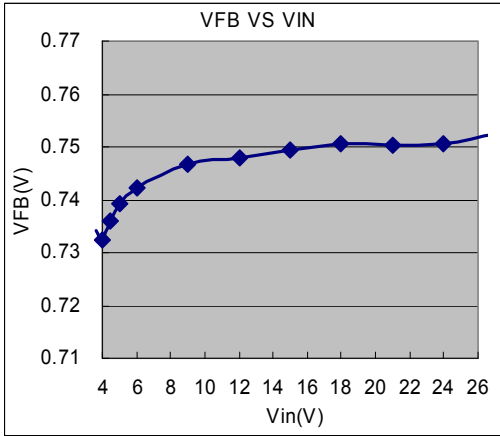

ICCQ VS VIN

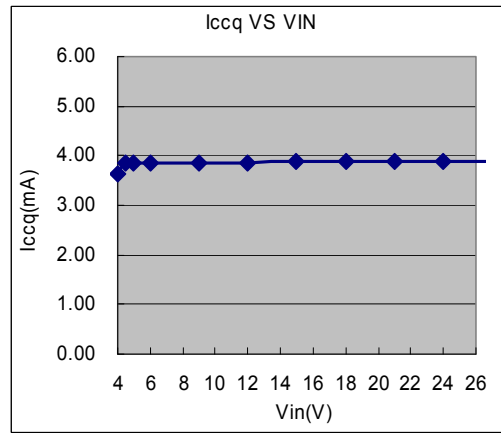

FOSC VS VIN

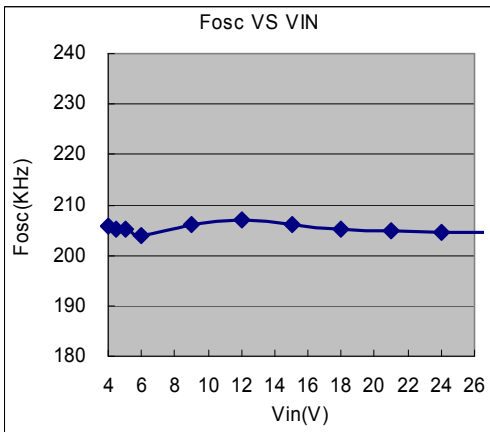

FOSC VS TEMPERATURE

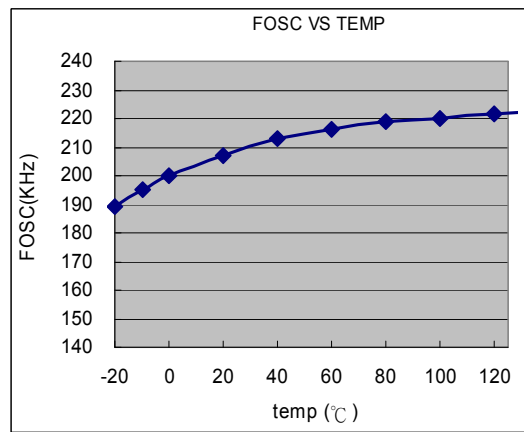

VFB VS TEMPERATURE

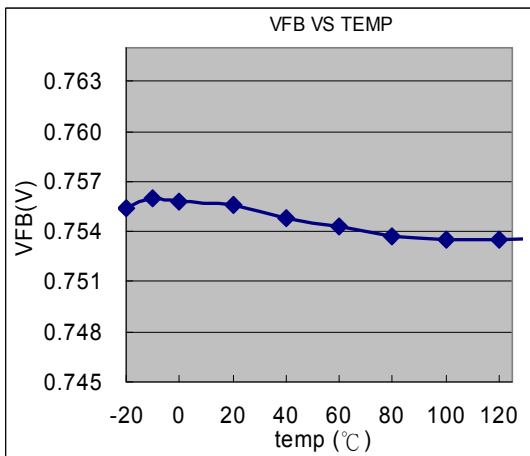

ICCQ VS TEMPERATURE

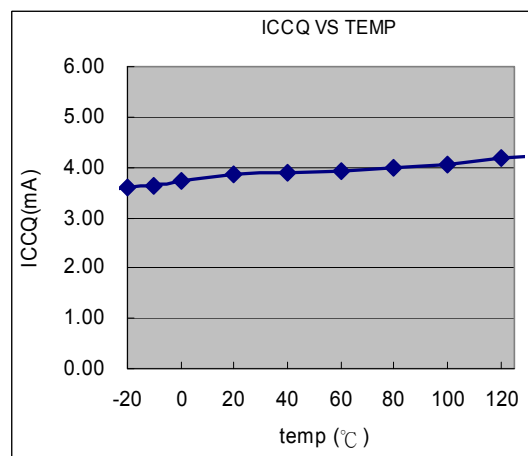

❖ TYPICAL CHARACTERISTICS (CONTINUES)

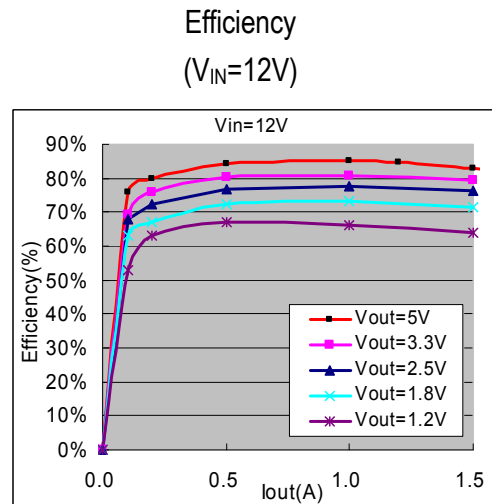
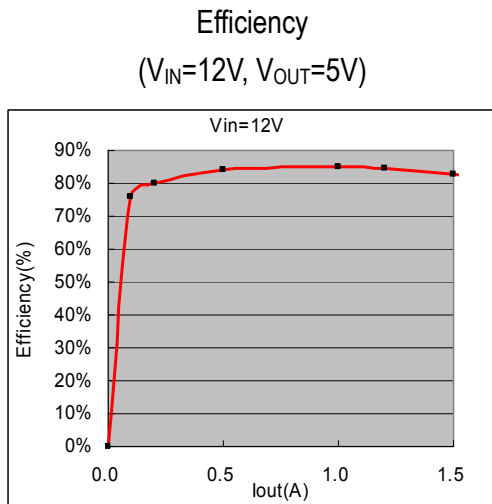
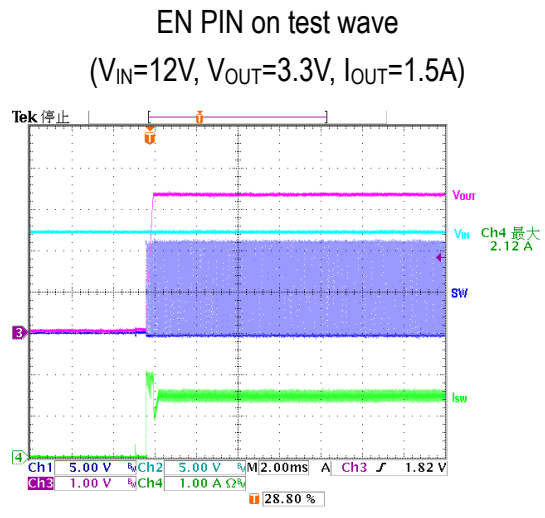
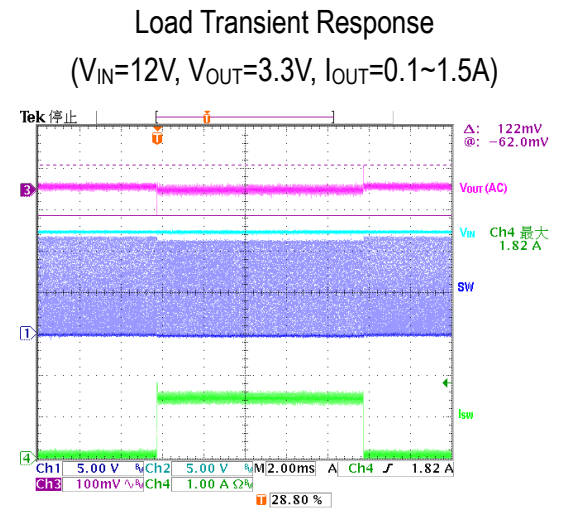
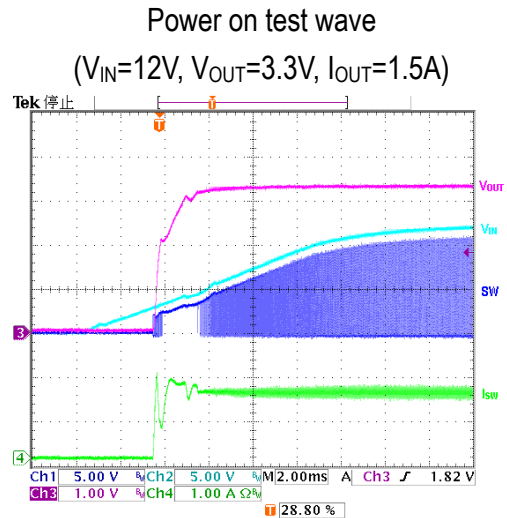
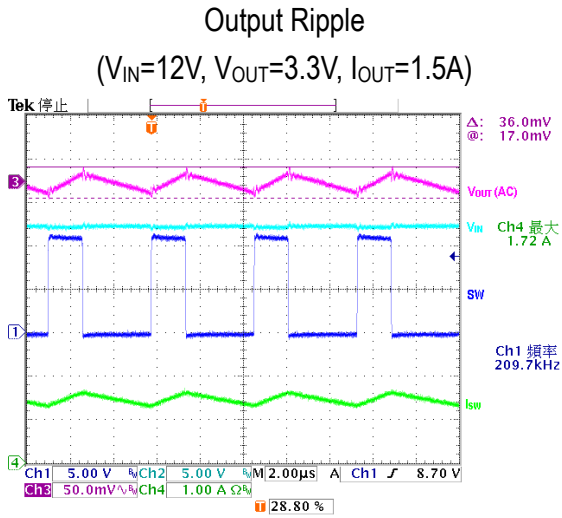

❖ PACKAGE OUTLINES

(1) SOT89-5L (Type1)

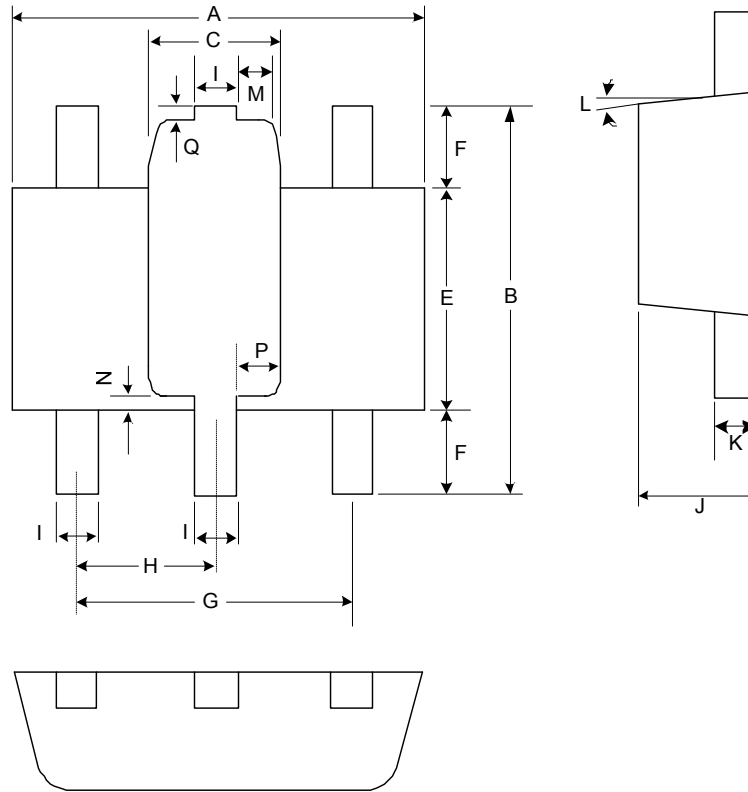

Symbol	Dimensions in Millimeters			Dimensions in Inches		
	Min.	Nom.	Max.	Min.	Nom.	Max.
A	4.40	4.50	4.60	0.173	0.177	0.181
B	4.05	4.15	4.25	0.159	0.163	0.167
C	1.40	1.60	1.70	0.055	0.062	0.067
E	2.40	2.50	2.60	0.094	0.098	0.102
F	0.80	-	-	0.031	-	-
G	3.00 REF.			0.118 REF.		
H	1.50 REF.			0.059 REF.		
I	0.36	0.46	0.53	0.014	0.018	0.02
J	1.40	1.50	1.60	0.055	0.059	0.063
K	0.35	0.39	0.43	0.014	0.015	0.017
L	8° TYP.			8° TYP.		
M	0.38	0.47	0.60	0.015	0.019	0.024
N	0.20	0.18	0.40	0.008	0.007	0.026
P	0.48	0.57	0.67	0.019	0.022	0.027
Q	-	-	0.40	-	-	0.016

JEDEC outline: NA

(2) SOT89-5L (Type2)

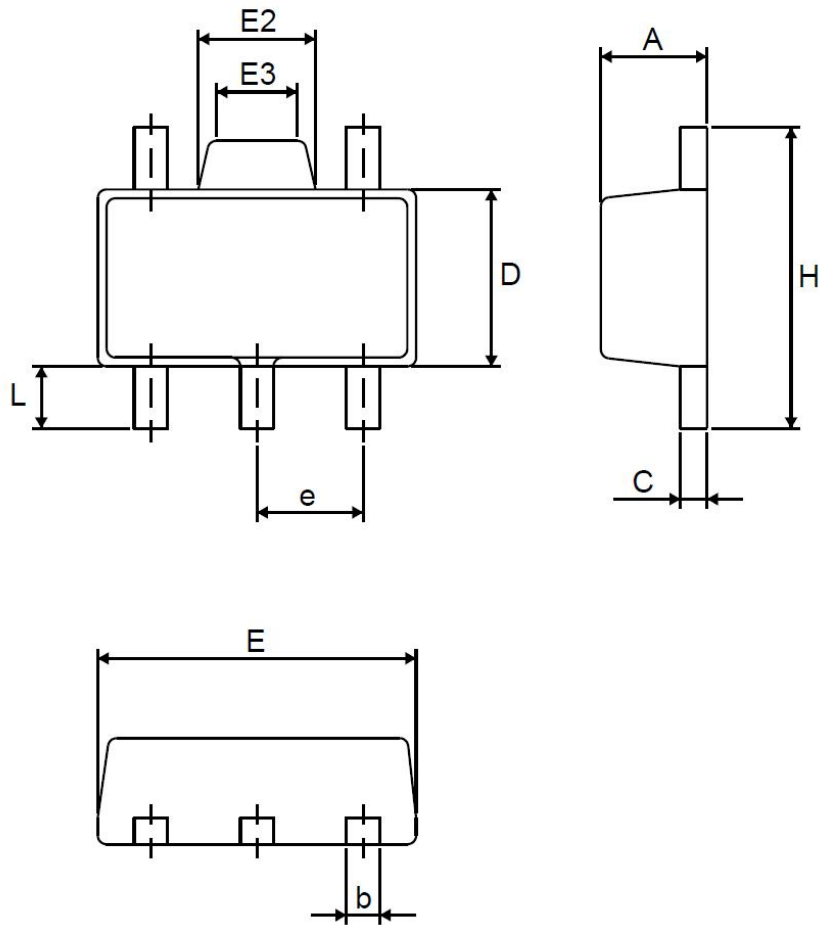

Symbol	Dimensions in Millimeters			Dimensions in Inches		
	Min.	Nom.	Max.	Min.	Nom.	Max.
A	1.450	1.500	1.550	0.057	0.059	0.061
b	0.440	0.460	0.480	0.017	0.018	0.019
C	0.360	0.380	0.400	0.014	0.015	0.016
D	2.450	2.500	2.550	0.096	0.098	0.100
E	4.450	4.500	4.550	0.175	0.177	0.179
E2	1.500	1.600	1.700	0.059	0.063	0.067
E3	1.400 REF			0.055 REF		
e	1.500 BSC			0.059 BSC		
H	4.140	4.200	4.250	0.163	0.165	0.167
L	0.800	-	0.950	0.032	-	0.038